

Kontur, Ghost, Dots  
& Palo Alto update

VIBIA

# VIBIA

## Current catalogues



General Catalogue 2020-2021

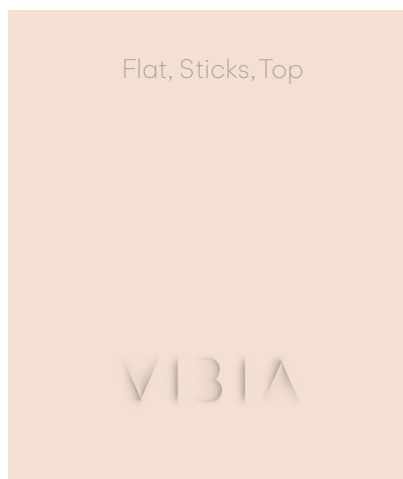

New Collections 1



New Collections 2

Kontur  
6

Ghost  
32

Dots  
54

Palo Alto  
update  
74

Detailed product  
information  
83

# Kontur

Design by Sebastian Herkner.

Providing a framework for light, the Kontur collection serves as an elegant stage setting for the linear light source it contains. Its minimalist black frame pairs with different diffusers or reflectors in a poetic balance, creating myriad lighting ambiances.





2700K LED colour temperature



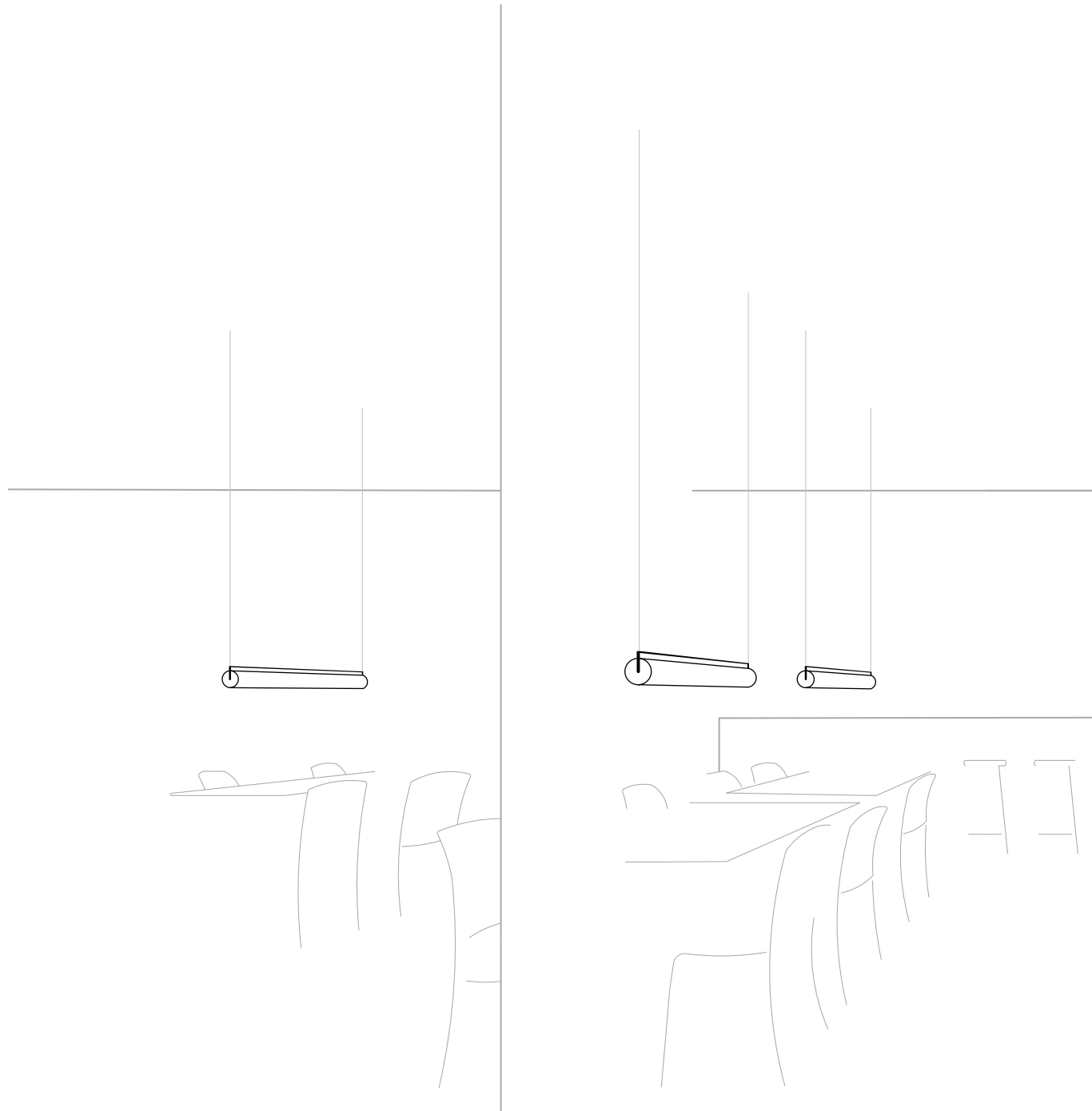



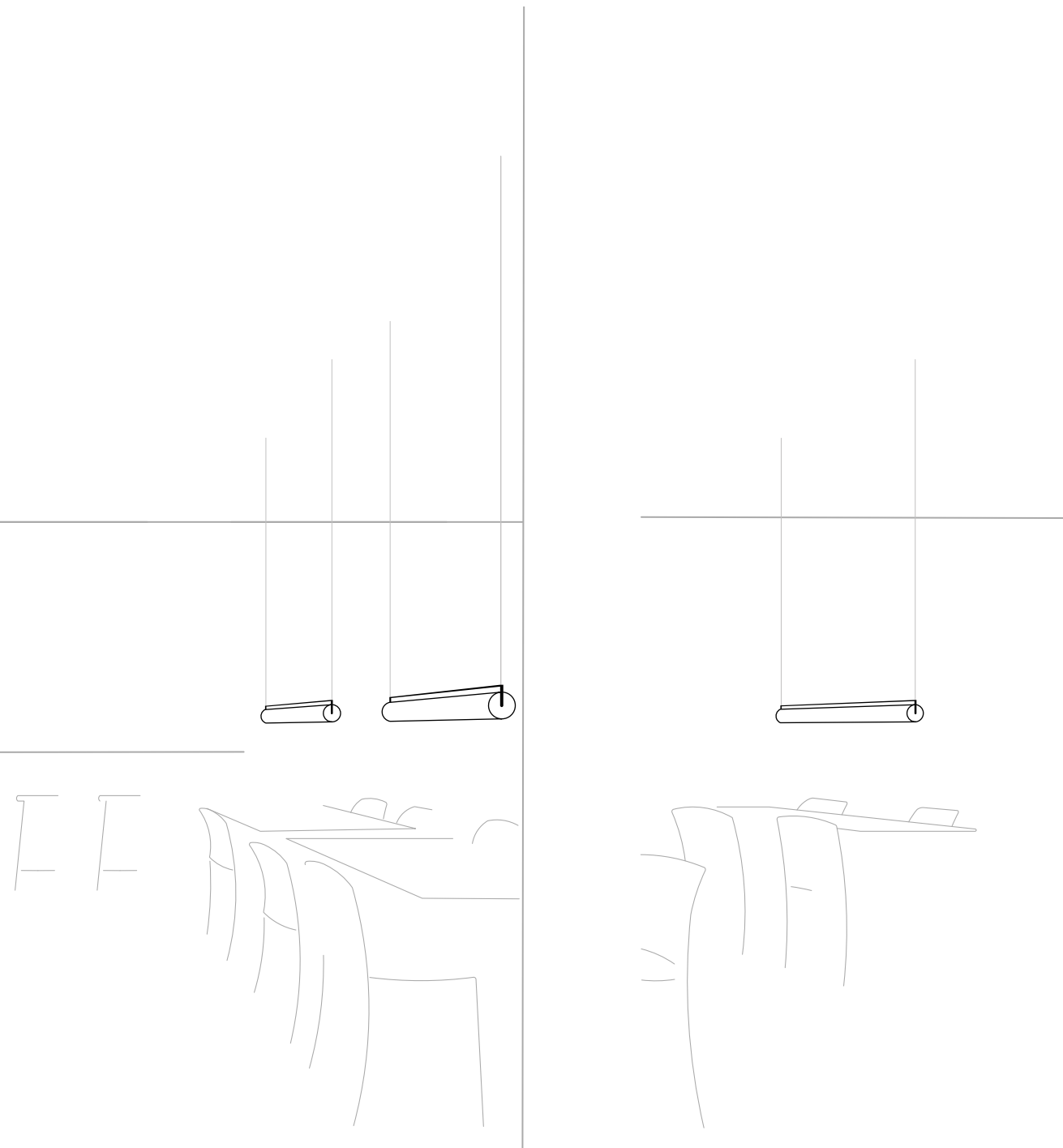

Compose personalised atmospheres with unique combinations of Kontur pendants in a space. Available in a range of LED colour temperatures of 2200 K, 2700 K, 3000 K, 4000 K for warm, candlelit looks or brighter, daytime effects.



Pure and refined, Kontur's cylindrical glass diffuser possesses a timeless sensibility. It generates a warm, 360-degree glow that recalls the romantic look.



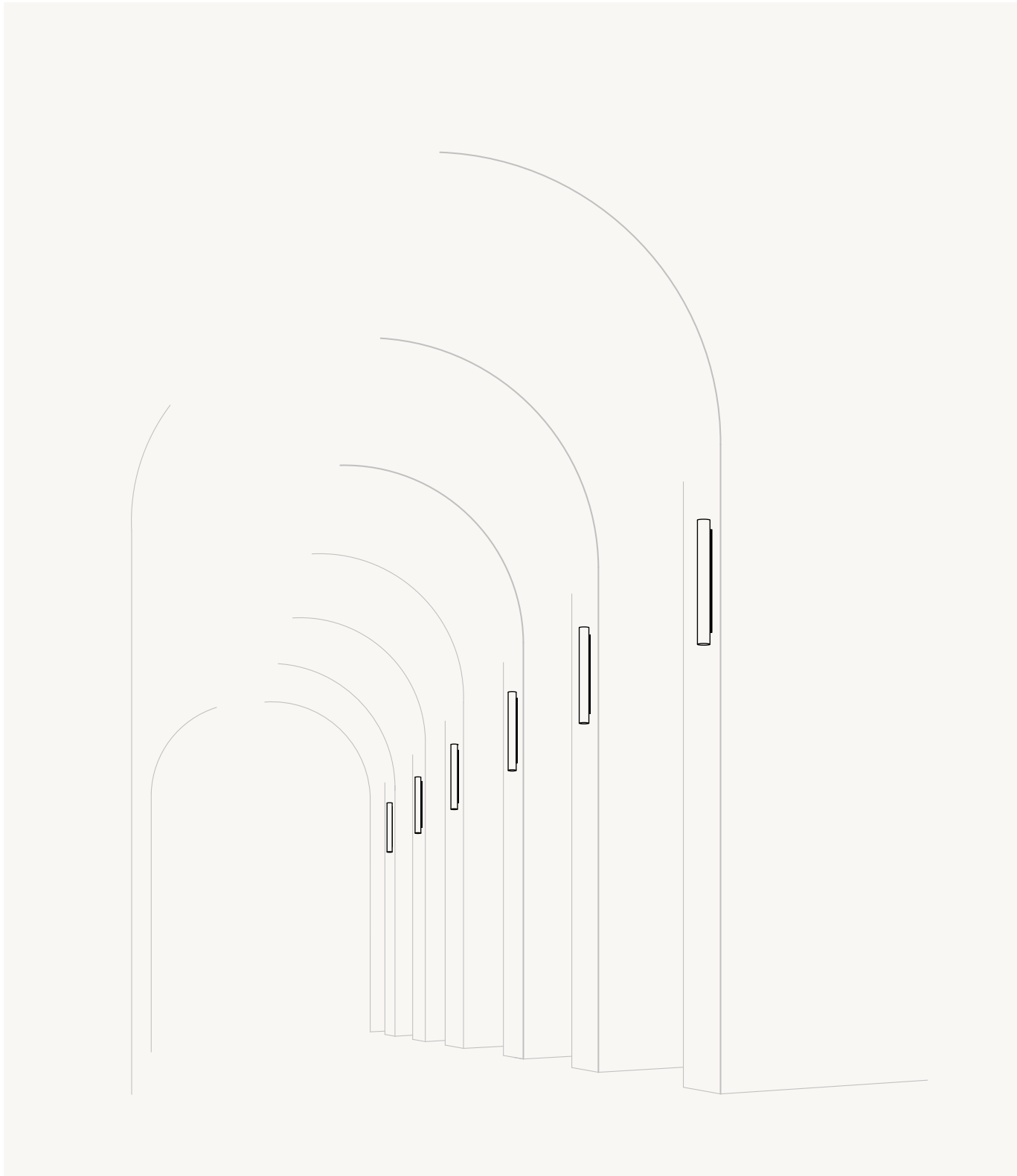



Large-scale glass wall lamp





2200 K LED colour temperature

“Kontur is about simplicity and balance. The light is very poetic and features a frame interacting with different shapes to generate myriad lighting moods and atmospheres.”

Sebastian Herkner.

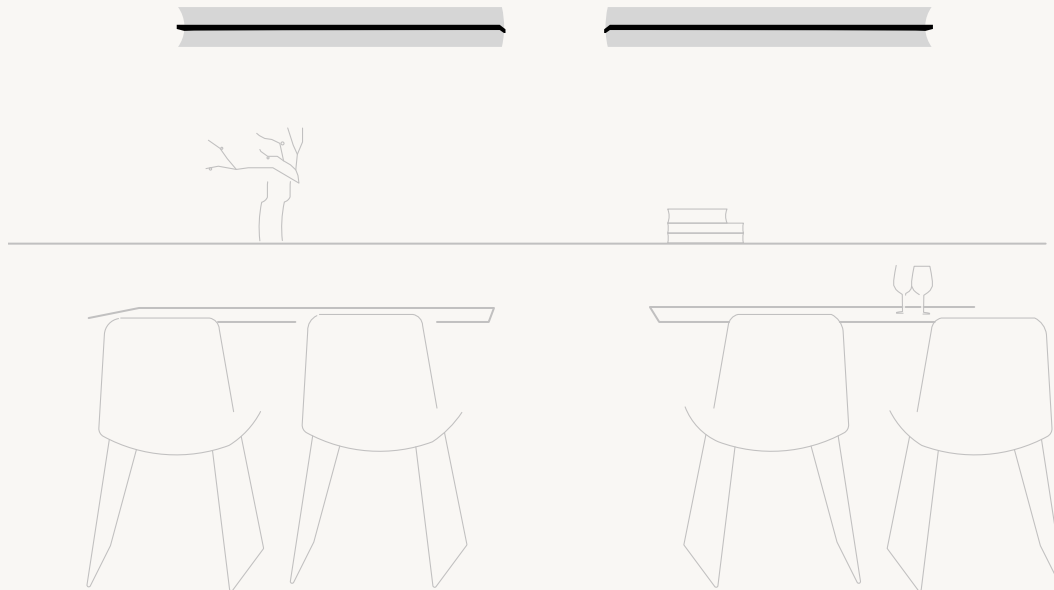





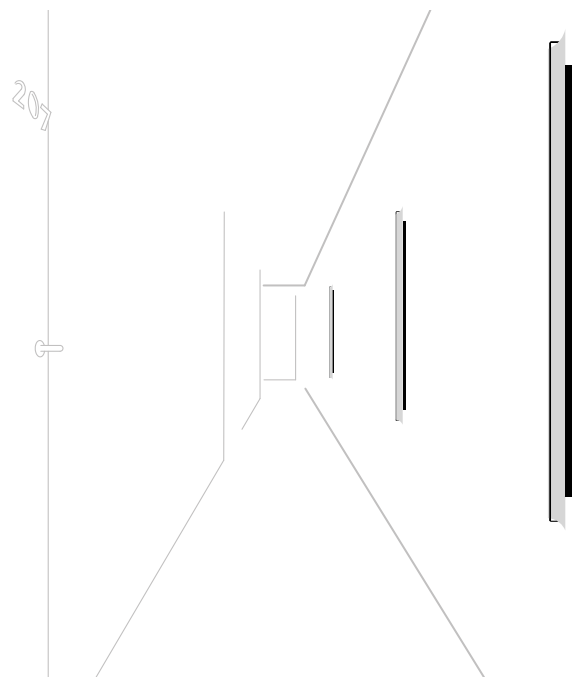





2200 K LED colour temperature



2700 K LED colour temperature





Kontur features a flat metal sheet formed into a rounded reflector, producing a poetic balance within its frame. The look, modern and architectural, lends itself perfectly to meeting or working area settings.





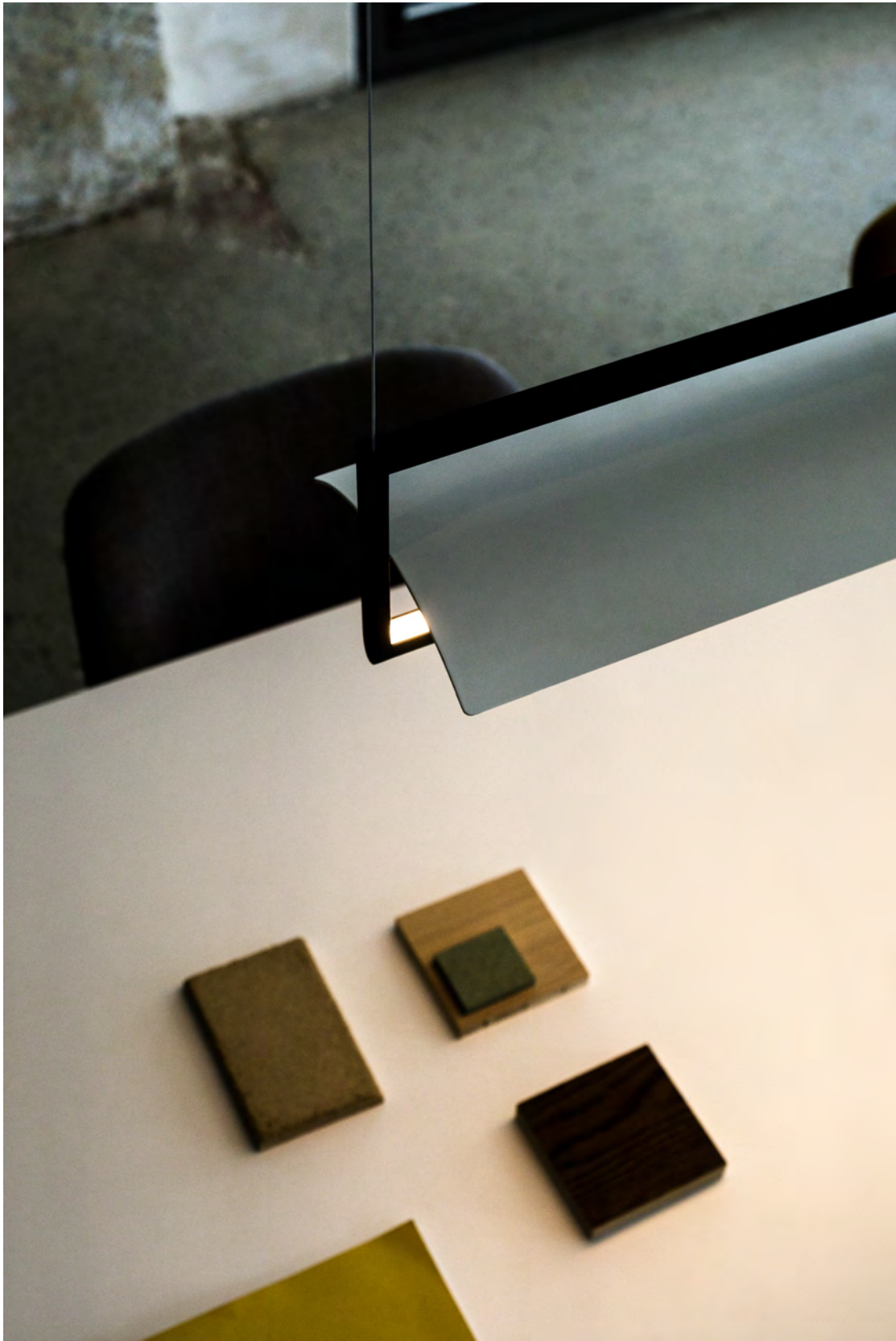





Defined by its sleek, black frame imbedded with LEDs, Kontur explores the concept of linear light with a curved metal reflector. The fine, concave form crafted from a sleek sheet of metal casts indirect illumination that lends the ambient look of raining light.

Kontur is available in two formats: a striking, large-scale wall lamp and a pendant that appears to float overhead from nearly invisible cables. These pure volumes are suspended in a state of elegant balance within their graphic geometric architecture, setting the stage for multiple lighting atmospheres.

● 11 Black (NCS S 8500-N)

Diffuser: Polycarbonate.  
Structures: Aluminum.  
Concave shade: Aluminum.

LED 2700 K. CRI >90. 104 lm/W.  
Dimming: 1-10V.

**Personalisation options available**

- LED 2200 K, 3000 K, 4000 K
  - Dimming: DALI, Push or Casambi
  - Hanging models
  - Extra cable length
- Request more information.

Aluminum Shade

6414

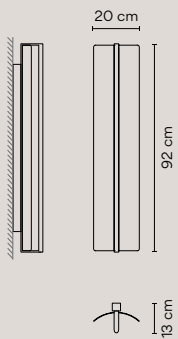

6416



6418



6434

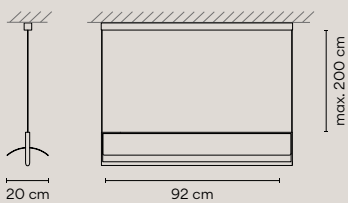

6436

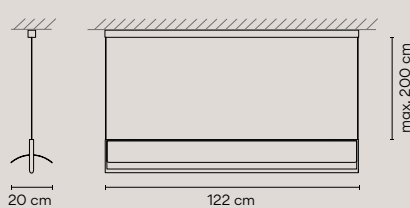

6438

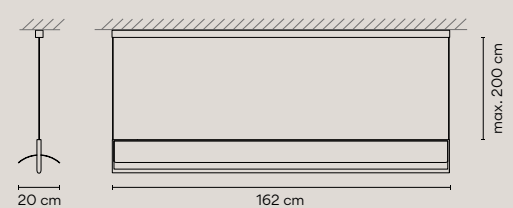

Distilled to its essence, Kontur glass is distinguished by a streamlined black frame imbedded with LEDs and paired with a cylindrical opaline diffuser. The opaque, mouthblown glass generates a warm, 360-degree glow as if from a fire, its circular silhouette playing counterpoint to the frame's crisp rectangular form. Kontur glass is available in two formats: a bold, large-scale wall lamp and a pendant that appears to float overhead from nearly invisible cables. Pure and elemental, the volumes produce a delicate balance within their graphic geometric architecture, setting the stage for multiple lighting ambiances.

● 11 Black (NCS S 8500-N)

Diffuser: Polycarbonate.  
Structures: Aluminum.  
Glass shade: Opal triplex.

LED 2700 K. CRI >90. 104 lm/W.  
Dimming: 1-10V.

**Personalisation options available**

- LED 2200 K, 3000 K, 4000 K
  - Dimming: DALI, Push or Casambi
  - Hanging models
  - Extra cable length
- Request more information.

Glass Shade

6444

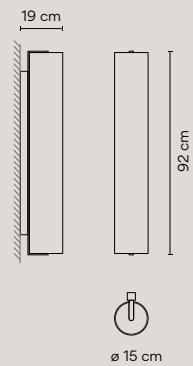

6446



6474

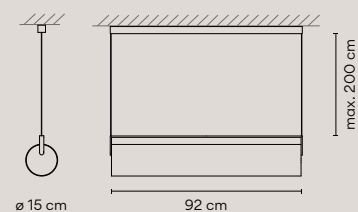

6476

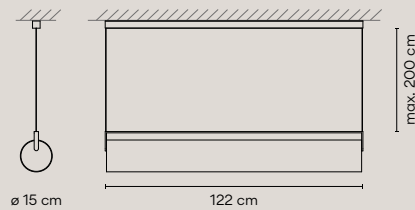

2200 K  
LED colour  
temperature option  
to create warm,  
candelit atmospheres.  
Available for both  
aluminum and  
glass shades.



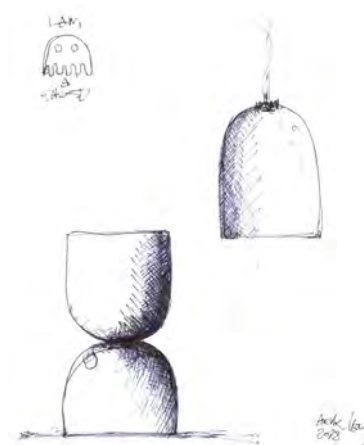

# Ghost

Design by Arik Levy.

A study in contrasts, the Ghost collection embodies both spirit and materiality, discretion and presence. A contemporary reimagining of the grand lights that once graced entryways and living areas, its sensuous form radiates a welcoming, luminous sensibility.







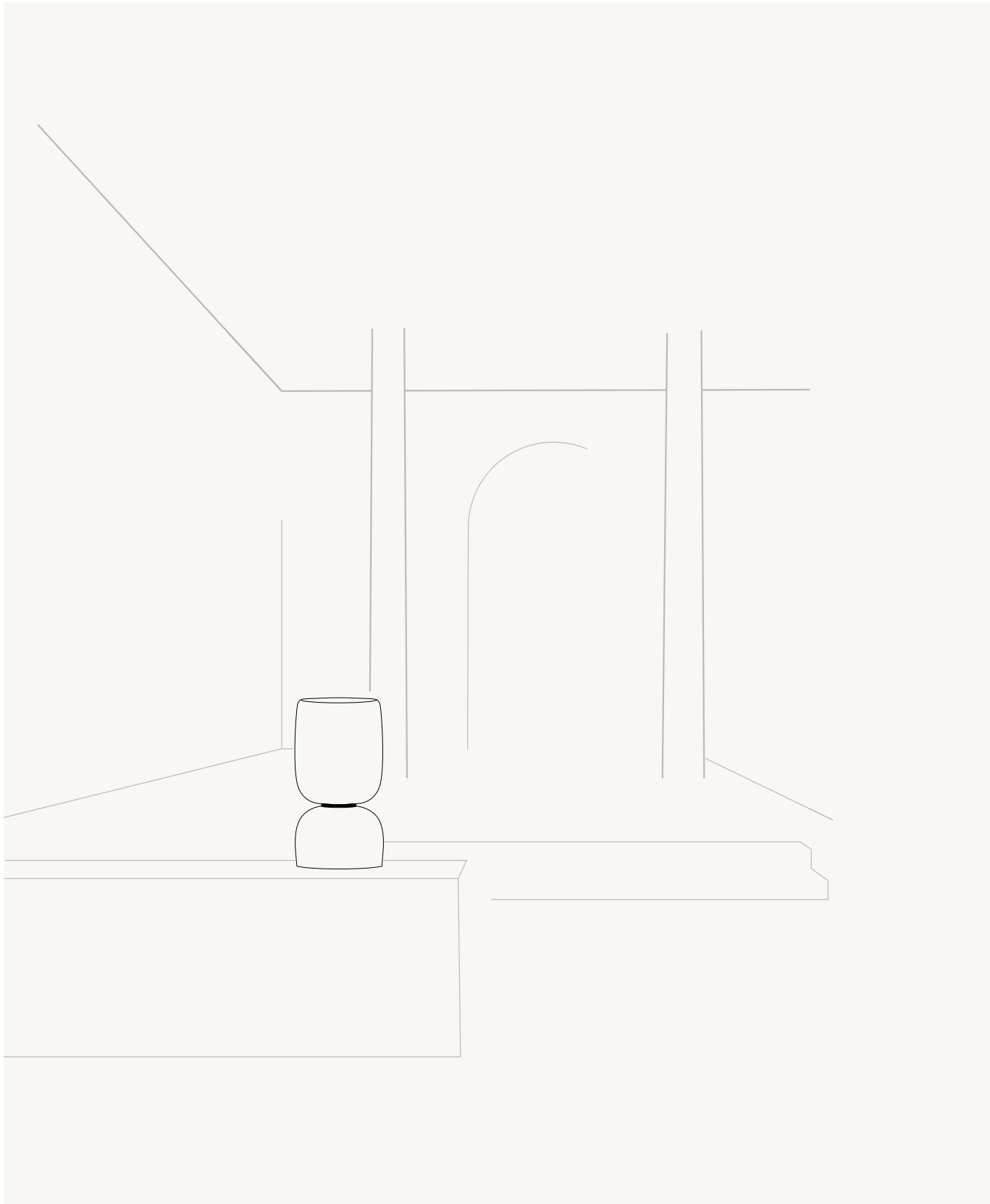







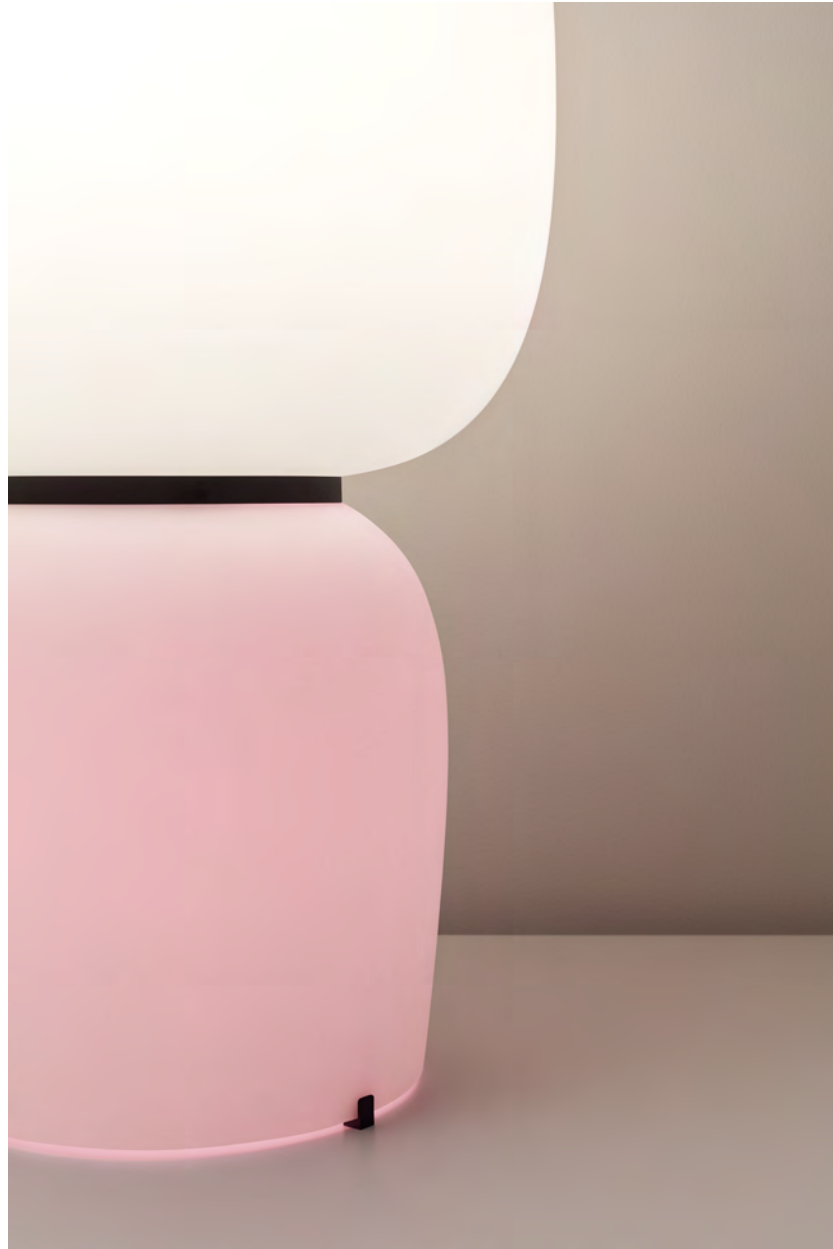

The Ghost table light uses a white diffuser but it comes with two colored diffusers -one amber and one burgundy - that can be placed in the lower piece of glass. With these diffusers, it creates an overall ochre or reddish light effect.











True to its namesake, Ghost evokes an ethereal presence that assumes its full effect when illuminated. A stacked silhouette of bulbous shapes is gracefully balanced, its generous form exuding a grounded, welcoming spirit. The black band encircling its midsection enhances the life-like feel. Serving as a touch dimmer for the push version, it evokes the sensuous curves of a person belted waist while offering wellbeing lighting atmospheres. Crafted of meticulously mouthblown opal triplex glass, Ghost's rich, smooth material generates a warm, ambient glow. Lower diffusers in a choice of white, burgundy and amber illuminate the tulip-like shapes for mix-and-match lighting effects.

● 11 Black (NCS S 8500-N)

Diffuser: Opal Glass.  
Metal parts: Aluminum.

LED 2700 K. CRI>90. 137 lm/W.  
/11 Dimming: DALI  
/15 Dimming: Push  
On-off & dimming (middle black frame).

#### Personalisation options available

- LED 4000 K
  - Dimming: 1-10V, Casambi.
  - Extra cable length.
- Request more information.



A colour glass diffuser can be placed in the lower glass for an amber or burgundy light effect.

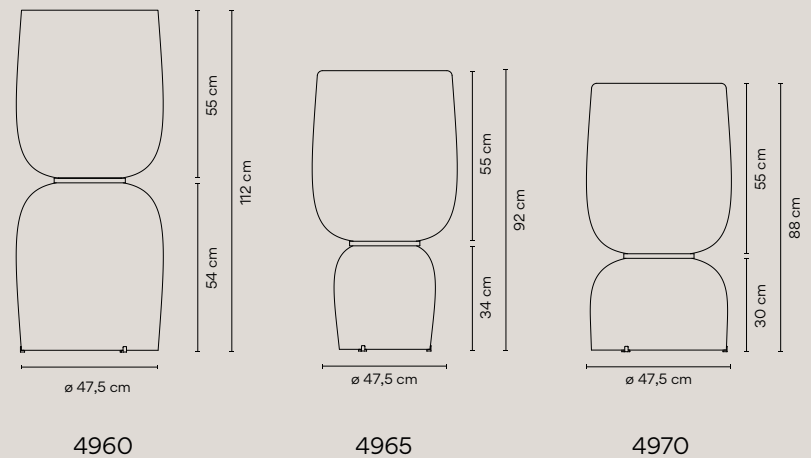

#### Dimming and installation options



/15: Push-dimming model equipped with two buttons, one for each diffuser. A quick push turns the light on and off, a longer presson dims the light.

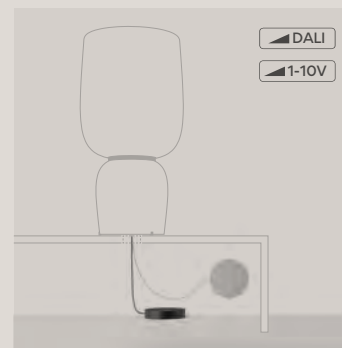
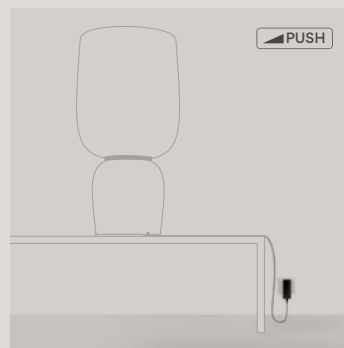

The driver of the DALI, 1-10V and Casambi versions is enclosed in a box at the end of the cable.

Arrayed in multiples for maximum visual impact, a group of Ghost pendants commands a space with their glowing, sculptural presence.

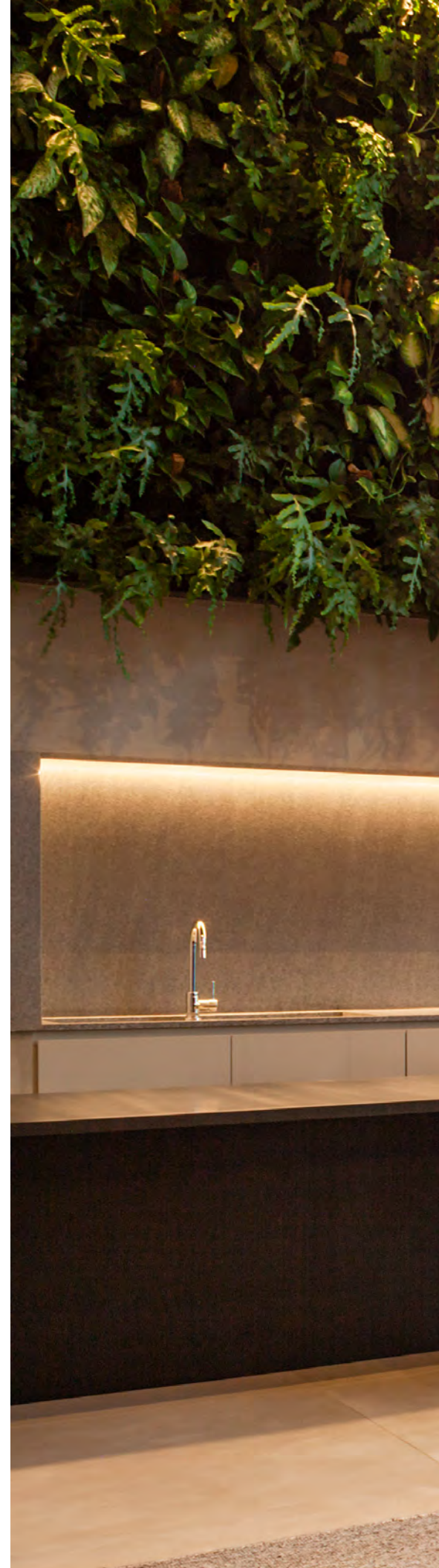







“Ghost is the pure expression of a state of mind, of the immateriality of mouthblown glass that projects a sensuous halo in space. This sensation is enhanced with the Ghost table lamp, a visual sculpture both when the light is on or off. Its double composition creates a family of giant and generous forms whose smooth surface and texture radiate a gentle and warm light. Despite its evanescence, it becomes a kind of companion in the living environment”

Arik Levy.

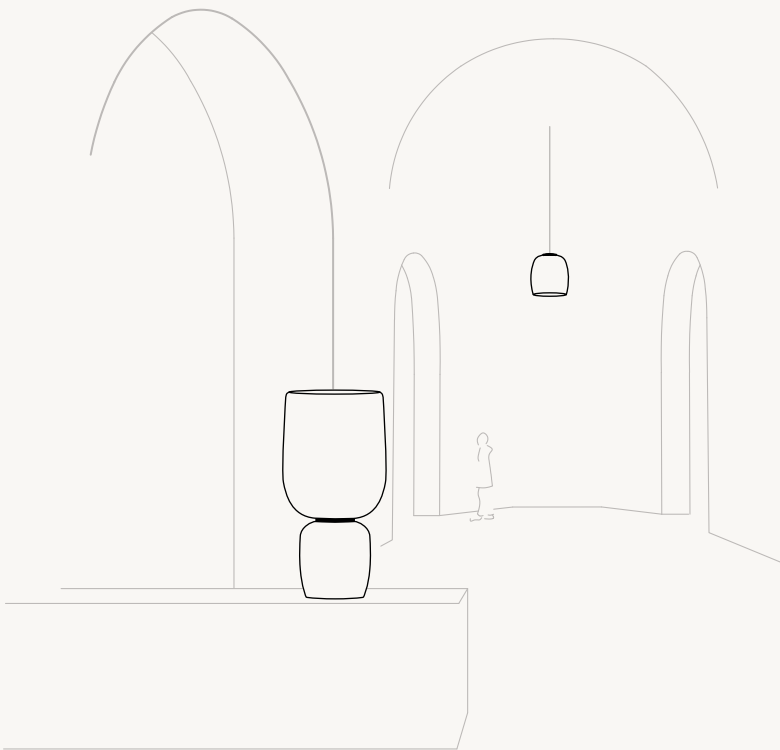





Evoking a luminous, ethereal presence, the Ghost pendant provides a focal point in any interior. Large in scale, yet elegant in attitude, the delicate luminaire floats overhead from nearly invisible cables. Its distinctive sculptural silhouette appears to descend like a spirit from the sky, suspended low for dramatic effect. Crafted of opal triplex glass that's meticulously mouthblown, Ghost's smooth surface radiates a warm, welcoming ambiance that bathes a space in soft light.

● 11 Black (NCS S 8500-N)

Diffuser: Opal Glass.  
Metal parts: Aluminum.

LED 2700 K. CRI>90. 149 lm/W.  
Dimming: DALI, 1-10V, Push.

#### Personalisation options available

- LED 4000 K
- Dimming: Casambi
- Extra cable length

Request more information.

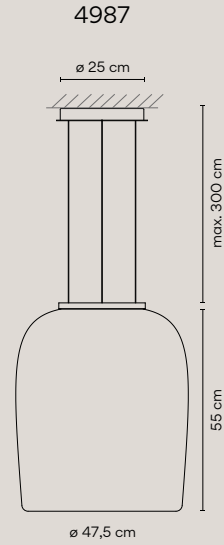

Diffuser: Opal Glass.  
Metal parts: Aluminum.





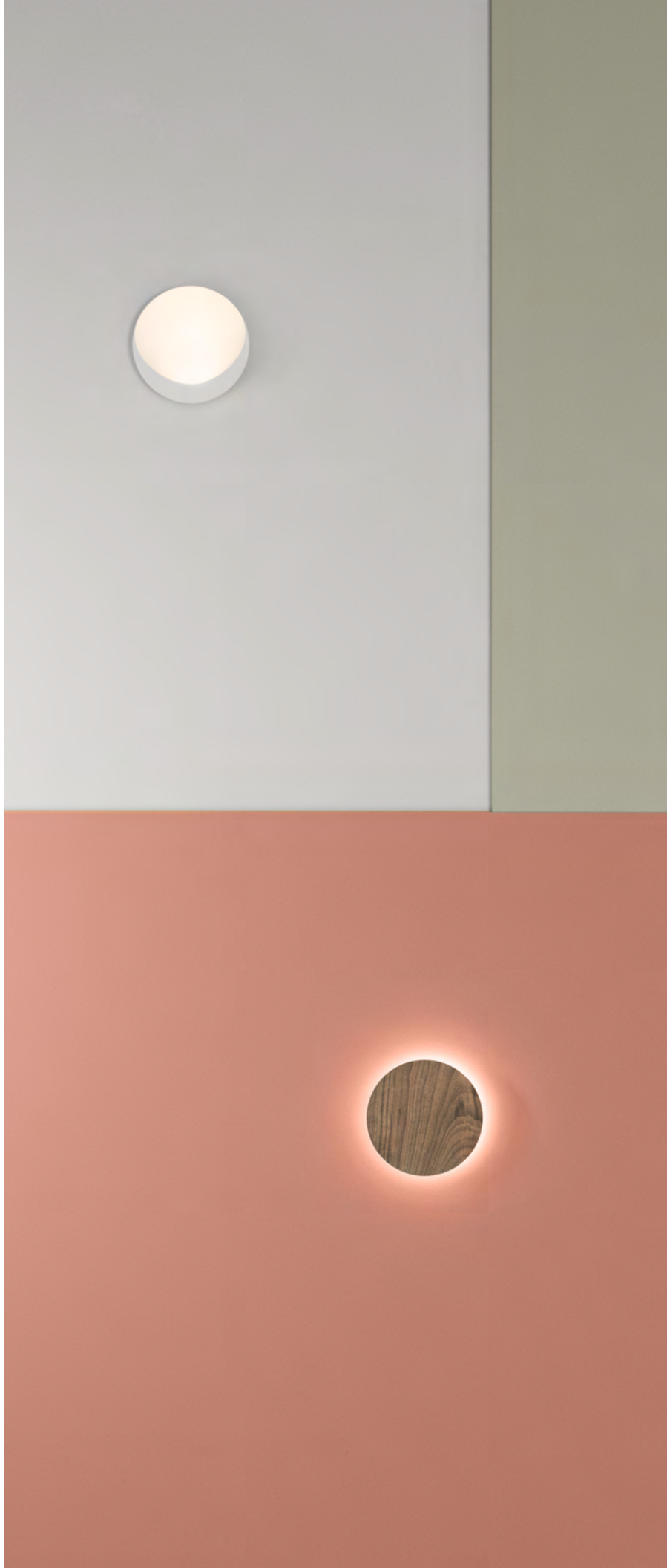

# Dots

Design by Martín Azúa.

A diminutive wall sconce delivers outsized impact in the form of simple, circular dots. Seamlessly connecting a space with an intimate landscape of beams and halos, the collection creates a melody of light like a composition of musical notes in concert with another.

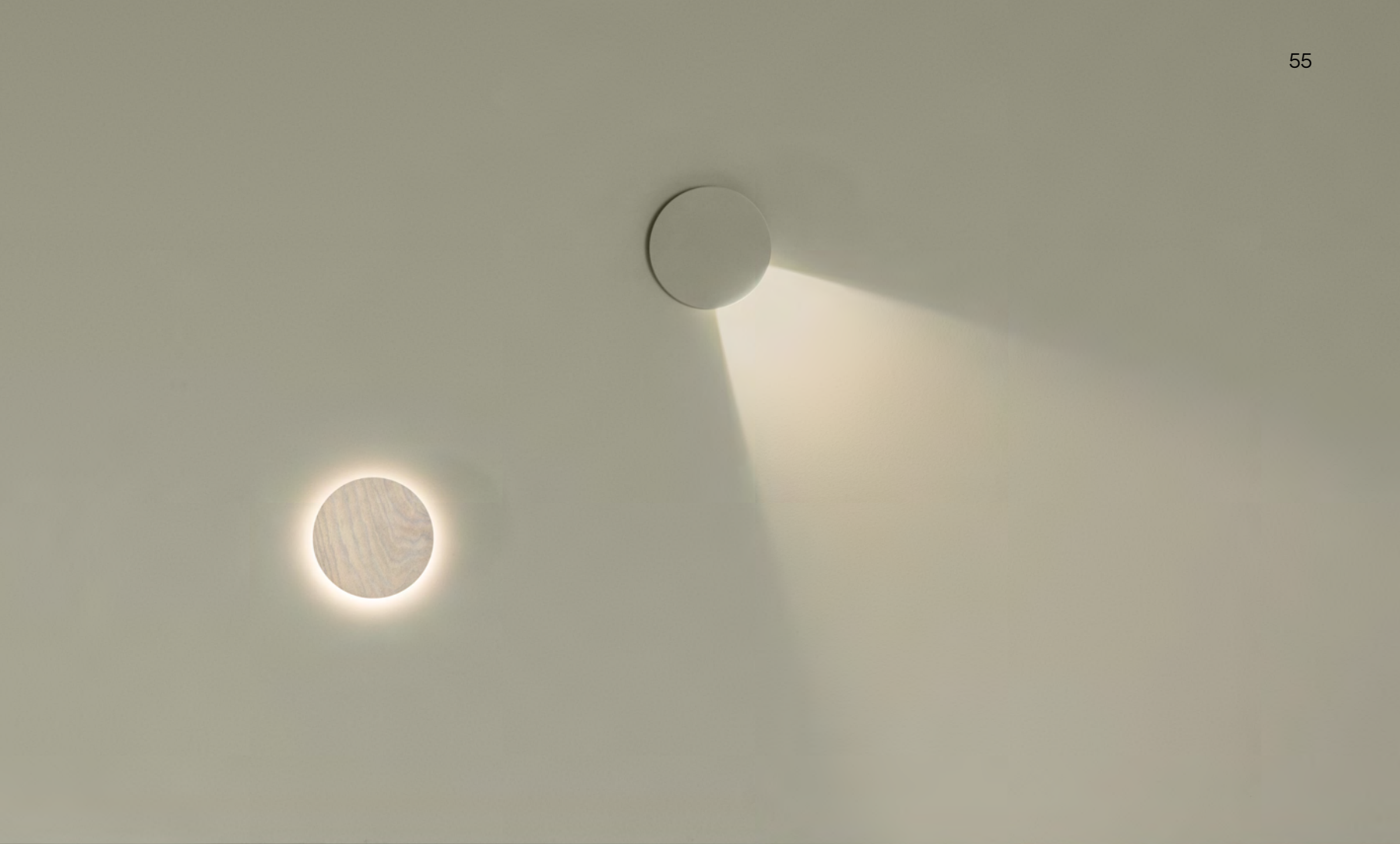



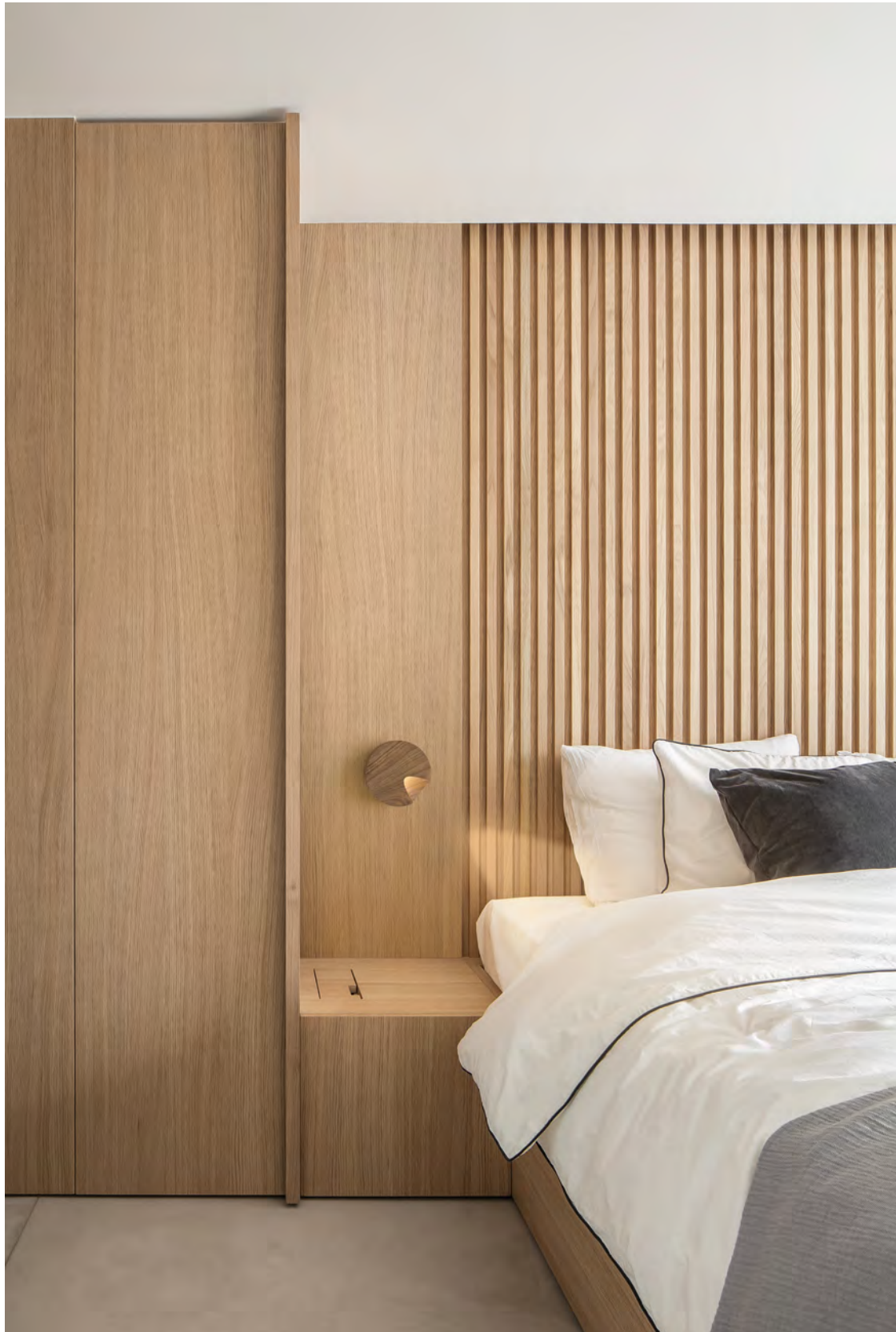



Its compact shape, range of colour finishes, and warm wood material make Dots very easy to integrate into a space.

4662 item with on-off switch on the back plate.









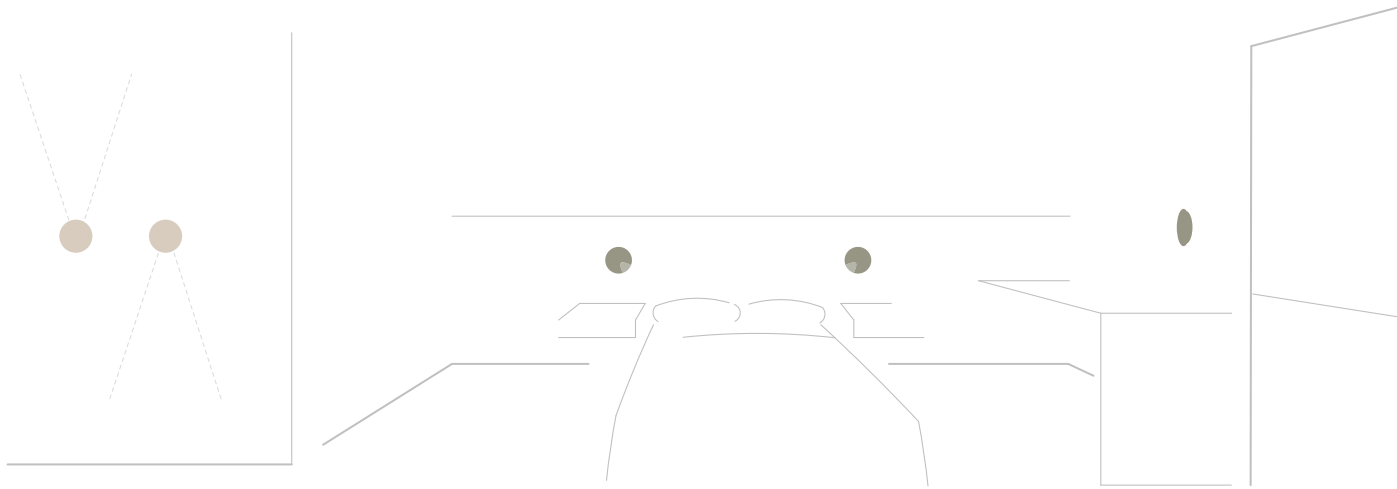

“Dots is a **simple, versatile lighting system** that offers many different solutions in one collection. If we forget the idea that wall lamps are boring, we can suddenly start playing with material, colours and lighting effects in group or individually to create comfortable atmospheres”.

Martín Azúa.

























Compact, glowing circles trace individual points of light across the wall with the Dots collection. Small in scale with a bold simplicity, the lamps offer personalised functionality in several versions: a graphic, directional light; an ambient, indirect light; and an accent/reading light.

Deployed alone like a sparkling jewel or in combination to create a glowing galaxy, the collection offers an intimate universe of light. The luminaires exude a fresh and playful feel, connecting a space while providing myriad lighting solutions. Dots is available in solid wood or lacquered in four of Vibia's Chromatica® colours.

Ref. 4665.

- 13 Grey L1 (NCS S 1000-N)
- 27 Brown L1 (NCS S 1505-Y50R)
- 37 Terra Red (NCS S 4040-Y70R)
- 47 Green L1 (NCS S 4005-G80Y)

Ref. 4660, 4662, 4670, 4675.

- 13 Grey L1 (NCS S 1000-N)
- 27 Brown L1 (NCS S 1505-Y50R)
- 37 Terra Red (NCS S 4040-Y70R)
- 47 Green L1 (NCS S 4005-G80Y)
- 82 White oak
- 83 American walnut

Body: ABS or Natural wood.  
Diffuser: Polycarbonate.  
Canopy: Aluminum.

LED 2700 K. CRI>90. 87 lm/W.

#### Personalisation options available

- Finish customisation  
(Available options: Vibia colour palette)
  - LED 4000 K
  - Ref. 4660, 4662, 4670 and 4675
  - Dimming: DALI, 1-10V, Triac.
- Request more information.

4660

Ajustable:  
360° turn.

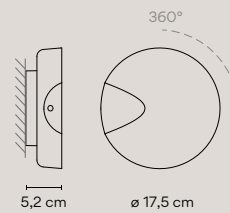

4662

Ajustable: 360° turn.  
On-off switch  
on the back plate.

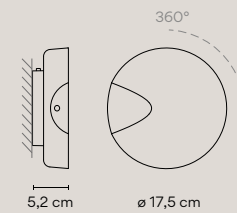

4665

Once installed  
position is fixed and  
cannot be adjusted.

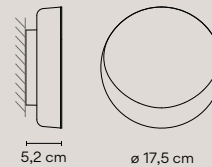

4670

Ajustable:  
360° turn.

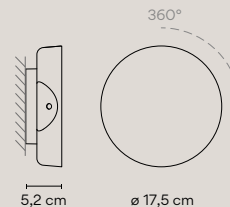

4675

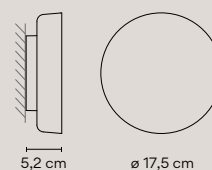

# Palo Alto update

Design by Xuclà.

At once natural and architectural, Palo Alto creates the effect of illuminated landscaping. Its angular, tree-shaped silhouette integrates seamlessly with the outdoors whether displayed individually or in a group.









A slender silhouette that better integrates into the landscape thanks to new heights, shapes, and branch angles.  
A new lighting solution with optical lenses which improves the light flux up to 10 fold.





At once natural and architectural, Palo Alto creates the effect of illuminated landscaping. Sleek and streamlined, its angular, tree-shaped silhouette integrates seamlessly with the outdoors. It is offered in various minimalist shapes and can be displayed individually or in a group to resemble a stand of trees. The upper reaches of the sturdy steel fixture are fitted with slim swaths of LEDs directed downwards to create diffused, ambient glow.

- 29 Brown D1 (NCS S 8005-Y50R)
- 53 Green M1 (NCS S 6005-G80Y)

Body: Steel.  
Cover: Steel.

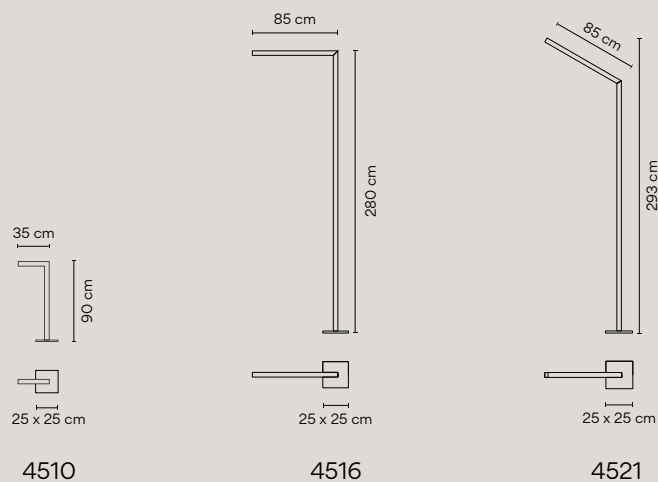

Ref. 4510  
LED 2700 K. CRI>90. 20 lm/W.

Ref. 4516  
LED 2700 K. CRI>90. 70 lm/W.

Ref. 4521 and 4537  
LED 2700 K. CRI>90. 69 lm/W.

Ref. 4538  
LED 2700 K. CRI>90. 68 lm/W.

Ground surface mounted.

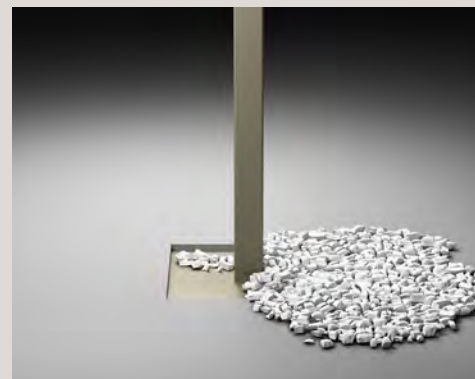
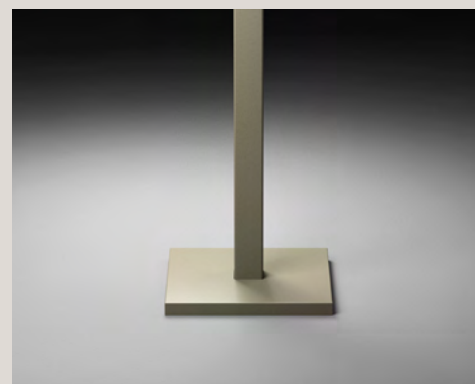
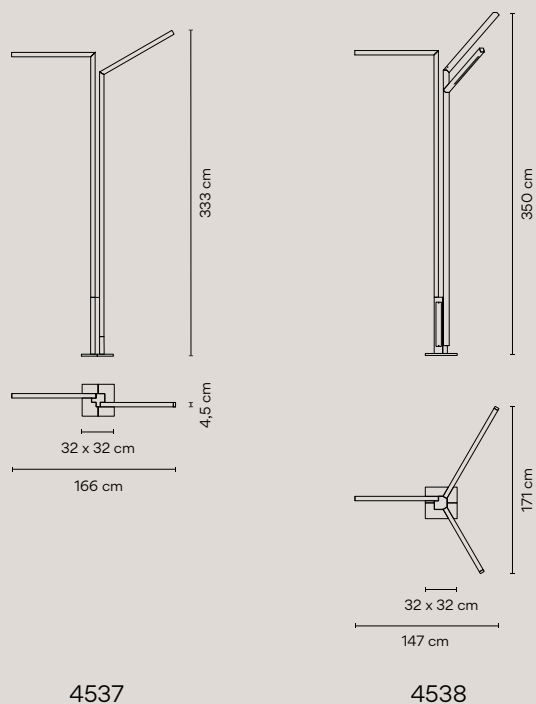



Detailed product information



# Kontur

Design by Sebastian Herkner.

## Wall



20 x 92 cm

**6414** p. 30



20 x 122 cm

**6416** p. 30



20 x 162 cm

**6418** p. 30

## Hanging



92 cm

**6434** p. 30

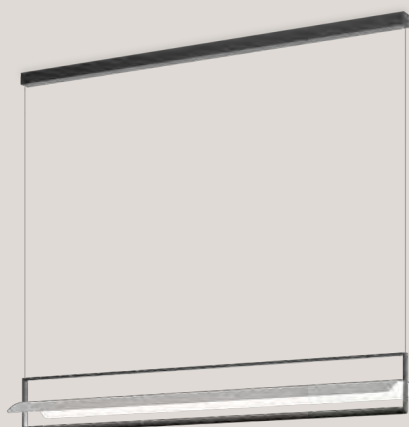

122 cm

**6436** p. 30



162 cm

**6438** p. 30

**6414**

1 x LED STRIP 20,8W 750mA.   
 LED 2700 K. CRI >90. 2165lm. 104lm/W.  
 Driver Constant Current 750mA. 90~305Vac. 50/60Hz.  
 Dimming: 1-10V.

**Personalisation options available**

- LED 2200 K, 3000 K, 4000 K.  
 - Dimming: DALI, Push or Casambi.  
 Request more information.

Concave shade: Aluminum.  
 Diffuser: Polycarbonate.  
 Structures: Steel.  
 Canopy: Aluminum.  
 Net weight 3,5 Kg.

**6414 11 /13** Black (NCS S 8500-N)





**6416**

1 x LED STRIP 27,9W 750mA.   
 LED 2700 K. CRI >90. 2907lm. 104lm/W.  
 Driver Constant Current 750mA. 90~305Vac. 50/60Hz.  
 Dimming: 1-10V.

**Personalisation options available**

- LED 2200 K, 3000 K, 4000 K.  
 - Dimming: DALI, Push or Casambi.  
 Request more information.

Concave shade: Aluminum.  
 Diffuser: Polycarbonate.  
 Structures: Steel.  
 Canopy: Aluminum.  
 Net weight 3,8 Kg.

**6416 11 /13** Black (NCS S 8500-N)





**6418**

1 x LED STRIP 37,2W 750mA.   
 LED 2700 K. CRI >90. 3876lm. 104lm/W.  
 Driver Constant Current 750mA. 90~305Vac. 50/60Hz.  
 Dimming: 1-10V.

**Personalisation options available**

- LED 2200 K, 3000 K, 4000 K.  
 - Dimming: DALI, Push or Casambi.  
 Request more information.

Concave shade: Aluminum.  
 Diffuser: Polycarbonate.  
 Structures: Steel.  
 Canopy: Aluminum.  
 Net weight 4 Kg.

**6418 11 /13** Black (NCS S 8500-N)





**6434**

1 x LED STRIP 20,8W 750mA.   
 LED 2700 K. CRI >90. 2165lm. 104lm/W.  
 Driver Constant Current 750mA. 90~305Vac. 50/60Hz.  
 Dimming: 1-10V.

**Personalisation options available**

- LED 2200 K, 3000 K, 4000 K.  
 - Dimming: DALI, Push or Casambi.  
 Request more information.

Concave shade: Aluminum.  
 Diffuser: Polycarbonate.  
 Structures: Steel.  
 Canopy: Aluminum.  
 Net weight 3,5 Kg.

**6434 11 /13** Black (NCS S 8500-N)





**6436**

1 x LED STRIP 27,9W 750mA.   
 LED 2700 K. CRI >90. 2907lm. 104lm/W.  
 Driver Constant Current 750mA. 90~305Vac. 50/60Hz.  
 Dimming: 1-10V.

**Personalisation options available**

- LED 2200, 3000, 4000 K.  
 - Dimming: DALI, Push or Casambi.  
 Request more information.

Concave shade: Aluminum.  
 Diffuser: Polycarbonate.  
 Structures: Steel.  
 Canopy: Aluminum.  
 Net weight 3,8 Kg.

**6436 11 /13** Black (NCS S 8500-N)





**6438**

1 x LED PLATE 37,2W 750mA.   
 LED 2700 K. CRI >90. 3876lm. 104lm/W.  
 Driver Constant Current 750mA. 90~305Vac. 50/60Hz.  
 Dimming: 1-10V.

**Personalisation options available**

- LED 2200, 3000, 4000 K.  
 - Dimming: DALI, Push or Casambi.  
 Request more information.

Concave shade: Aluminum.  
 Diffuser: Polycarbonate.  
 Structures: Steel.  
 Canopy: Aluminum.  
 Net weight 4 Kg.

**6438 11 /13** Black (NCS S 8500-N)





---

Wall



19 x 92 cm

**6444** p. 31



19 x 122 cm

**6446** p. 31

---

Hanging



92 cm

**6474** p. 31



122 cm

**6476** p. 31

---

**6444**1 x LED STRIP 20,8W 750mA. 

LED 2700 K. CRI &gt;90. 2165lm. 104lm/W.

Driver Constant Current 750mA. 90~305Vac. 50/60Hz.

Dimming: 1-10V.

**Personalisation options available**

- LED 2200 K, 3000 K, 4000 K.
  - Dimming: DALI, Push or Casambi.
- Request more information.

Glass shade: Opal triplex.

Diffuser: Polycarbonate.

Structures: Steel.

Canopy: Aluminum.

Net weight 3,7 Kg.

**6444 11 /13** Black (NCS S 8500-N) 





**6446**1 x LED STRIP 27,9W 750mA. 

LED 2700 K. CRI &gt;90. 2907lm. 104lm/W.

Driver Constant Current 750mA. 90~305Vac. 50/60Hz.

Dimming: 1-10V.

**Personalisation options available**

- LED 2200 K, 3000 K, 4000 K.
  - Dimming: DALI, Push or Casambi.
- Request more information.

Glass shade: Opal triplex.

Diffuser: Polycarbonate.

Structures: Steel.

Canopy: Aluminum.

Net weight 6 Kg.

**6446 11 /13** Black (NCS S 8500-N) 





**6474**1 x LED STRIP 20,8W 750mA. 

LED 2700 K. CRI &gt;90. 2165 lm. 104lm/W.

Driver Constant Current 750mA. 90~305Vac. 50/60Hz.

Dimming: 1-10V.

**Personalisation options available**

- LED 2200 K, 3000 K, 4000 K.
  - Dimming: DALI, Push or Casambi.
- Request more information.

Glass shade: Opal triplex.

Diffuser: Polycarbonate.

Structures: Steel.

Canopy: Aluminum.

Net weight 3,7 Kg.

**6474 11 /13** Black (NCS S 8500-N) 





**6476**1 x LED STRIP 27,9W 750mA. 

LED 2700 K. CRI &gt;90. 2907lm. 104lm/W.

Driver Constant Current 750mA. 90~305Vac. 50/60Hz.

Dimming: 1-10V.

**Personalisation options available**

- LED 2200 K, 3000 K, 4000 K.
  - Dimming: DALI, Push or Casambi.
- Request more information.

Glass shade: Opal triplex.

Diffuser: Polycarbonate.

Structures: Steel.

Canopy: Aluminum.

Net weight 6 Kg.

**6476 11 /13** Black (NCS S 8500-N) 





# Ghost

Design by Arik Levy.

Hanging



Ø 47,5 cm

**4987** p. 52

Table



Ø 47,5 cm

**4960** p. 45

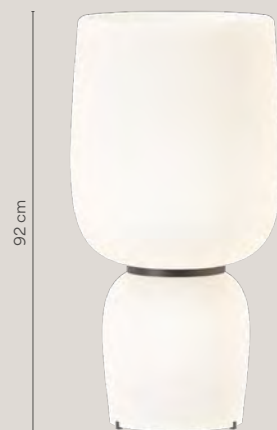

Ø 47,5 cm

**4965** p. 45



Ø 47,5 cm

**4970** p. 45

**4987**1 x LED 37,2W 1050mA. 

LED 2700 K. CRI &gt;90 5547 lm. 149 lm/W.

Driver Constant Current 1050mA. 100~240V. 50/60Hz.

Dimming: DALI, 1-10V, Push.

**Personalisation options available**

- LED 4000 K.
  - Dimming: Casambi.
  - Extra cable length.
- Request more information.

Diffuser: Opal Glass.  
Metal parts: Aluminum.  
Net weight 12,4 Kg.

**4987 11 /1A** Black (NCS S 8500-N) ●





**4960**2 x LED 19,8W 42V. 

LED 2700 K. CRI &gt;90. 5432 lm. 137 lm/W.

Driver Constant Voltage 42V. 100~240V. 50/60Hz.

/ 11 Dimming: DALI

/ 15 Dimming: Push

**Personalisation options available**

- LED 4000 K.
  - Dimming: 1-10V, Casambi.
  - Extra cable length.
- Request more information.

Diffuser: Opal Glass.  
Metal parts: Aluminum.  
Net weight 22,7 Kg.

**4960 11 /11** Black (NCS S 8500-N) ●





**4960 11 /15** Black (NCS S 8500-N) ●





**4965**2 x LED 19,8W 42V. 

LED 2700 K. CRI &gt;90. 5432 lm. 137 lm/W.

Driver Constant Voltage 42V. 100~240V. 50/60Hz.

/ 11 Dimming: DALI

/ 15 Dimming: Push

**Personalisation options available**

- LED 4000 K.
  - Dimming: 1-10V, Casambi.
  - Extra cable length.
- Request more information.

Diffuser: Opal Glass.  
Metal parts: Aluminum.  
Net weight 17,6 Kg.

**4965 11 /11** Black (NCS S 8500-N) ●





**4965 11 /15** Black (NCS S 8500-N) ●





**4970**2 x LED 19,8W 42V. 

LED 2700 K. CRI &gt;90. 5432 lm. 137 lm/W.

Driver Constant Voltage 42V. 100~240V. 50/60Hz.

/ 11 Dimming: DALI

/ 15 Dimming: Push

**Personalisation options available**

- LED 4000 K.
  - Dimming: 1-10V, Casambi.
  - Extra cable length.
- Request more information.

Diffuser: Opal Glass.  
Metal parts: Aluminum.  
Net weight 18,7 Kg.

**4970 11 /11** Black (NCS S 8500-N) ●





**4970 11 /15** Black (NCS S 8500-N) ●







# Dots

Design by Martín Azúa.

---

Wall

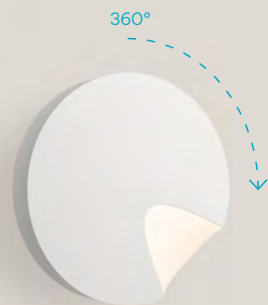

Ø 17,5 cm

Ajustable: 360° turn.  
4662: On-off switch on the back plate.

**4660 - 4662** p. 73



Ø 17,5 cm

Once installed position is  
fixed and cannot be adjusted.

**4665** p. 73

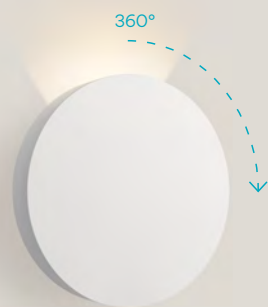

Ø 17,5 cm

Ajustable: 360° turn.

**4670** p. 73



Ø 17,5 cm

**4675** p. 73

---

**4660**







1 x LED 5,75W 500mA.   
 LED 2700 K. CRI >90. 500 lm. 87 lm/W.  
 Driver Constant Current 500 mA. 220~240V. 50/60Hz.

**Personalisation options available**

- Finish customisation  
(Available options: Vibia colour palette)
  - LED 4000 K.
  - Dimming: DALI, 1-10V, Triac.
- Request more information.

Body: ABS or Natural wood.  
 Diffuser: Polycarbonate.  
 Canopy: Aluminum.

ABS:  
 Net weight 0,4 Kg.  
 Natural wood:  
 Net weight 0,6 Kg.

4660 13 /10 Grey L1 (NCS S 1000-N) 4660 27 /10 Brown L1 (NCS S 1505-Y50R) 4660 37 /10 Terra Red (NCS S 4040-Y70R) 4660 47 /10 Green L1 (NCS S 4005-G80Y) 4660 82 /10 White oak 4660 83 /10 American walnut LED   IP20  CE**4662**

1 x LED 5,75W 500mA.   
 LED 2700 K. CRI >90. 500 lm. 87 lm/W.  
 Driver Constant Current 500 mA. 220~240V. 50/60Hz.





On-off switch on the back plate.

**Personalisation options available**

- Finish customisation  
(Available options: Vibia colour palette)
  - LED 4000 K.
  - Dimming: DALI, 1-10V, Triac.
- Request more information.

Body: ABS or Natural wood.  
 Diffuser: Polycarbonate.  
 Canopy: Aluminum.

ABS:  
 Net weight 0,4 Kg.  
 Natural wood:  
 Net weight 0,6 Kg.



4662 13 /10 Grey L1 (NCS S 1000-N) 4662 27 /10 Brown L1 (NCS S 1505-Y50R) 4662 37 /10 Terra Red (NCS S 4040-Y70R) 4662 47 /10 Green L1 (NCS S 4005-G80Y) 4662 82 /10 White oak 4662 83 /10 American walnut LED   IP20  CE**4665**

1 x LED 5,75W 500mA.   
 LED 2700 K. CRI >90. 500 lm. 87 lm/W.  
 Driver Constant Current 500 mA. 220~240V. 50/60Hz.

**Personalisation options available**

- Finish customisation  
(Available options: Vibia colour palette)
  - LED 4000 K.
- Request more information.

Body: ABS.  
 Diffuser: Polycarbonate.  
 Canopy: Aluminum.  
 Net weight 0,4 Kg.

4665 13 /10 Grey L1 (NCS S 1000-N) 4665 27 /10 Brown L1 (NCS S 1505-Y50R) 4665 37 /10 Terra Red (NCS S 4040-Y70R) 4665 47 /10 Green L1 (NCS S 4005-G80Y) LED   IP20  CE**4670**







1 x LED 5,75W 500mA.   
 LED 2700 K. CRI >90. 500 lm. 87 lm/W.  
 Driver Constant Current 500 mA. 220~240V. 50/60Hz.

**Personalisation options available**

- Finish customisation  
(Available options: Vibia colour palette)
  - LED 4000 K.
  - Dimming: DALI, 1-10V, Triac.
- Request more information.

Body: ABS or Natural wood.  
 Diffuser: Polycarbonate.  
 Canopy: Aluminum.

ABS:  
 Net weight 0,4 Kg.  
 Natural wood:  
 Net weight 0,6 Kg.

4670 13 /10 Grey L1 (NCS S 1000-N) 4670 27 /10 Brown L1 (NCS S 1505-Y50R) 4670 37 /10 Terra Red (NCS S 4040-Y70R) 4670 47 /10 Green L1 (NCS S 4005-G80Y) 4670 82 /10 White oak 4670 83 /10 American walnut LED   IP20  CE**4675**





1 x LED PLATE 4,5W 500mA.   
 LED 2700 K. CRI >90. 400 lm. 89 lm/W.  
 Driver Constant Current 500 mA. 100~240V. 50/60Hz.

**Personalisation options available**

- Finish customisation  
(Available options: Vibia colour palette)
  - LED 4000 K.
  - Dimming: DALI, 1-10V, Triac.
- Request more information.

Body: ABS or Natural wood.  
 Diffuser: Polycarbonate.  
 Canopy: Aluminum.

ABS:  
 Net weight 0,4 Kg.  
 Natural wood:  
 Net weight 0,6 Kg.

4675 13 /10 Grey L1 (NCS S 1000-N) 4675 27 /10 Brown L1 (NCS S 1505-Y50R) 4675 37 /10 Terra Red (NCS S 4040-Y70R) 4675 47 /10 Green L1 (NCS S 4005-G80Y) 4675 82 /10 White oak 4675 83 /10 American walnut LED   IP20  CE



# Palo Alto Update

Design by Xuclà.

Outdoor

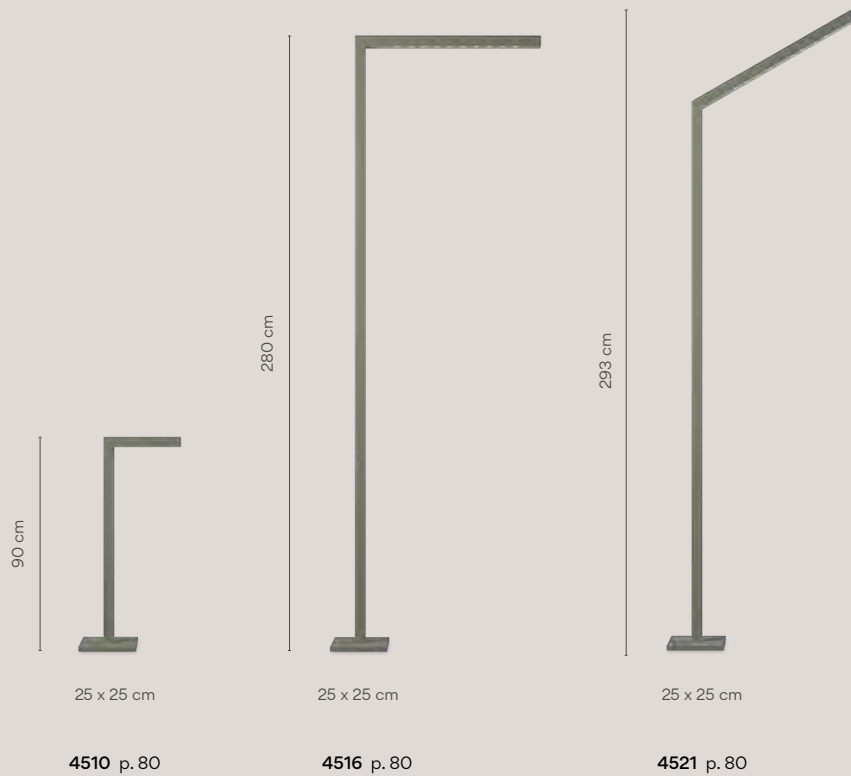

**4510**  
2 x LED 2,2W 700mA.   
LED 2700 K. CRI > 90. 179,64 lm. 20 lm/W  
Driver Constant Current 700mA. 220~240V. 50/60Hz.

Body: Steel.  
Cover: Steel.  
Net weight: 10 Kg.

**4510 29 /10** Brown D1 (NCS S 8005-Y50R)

**4510 53 /10** Green M1 (NCS S 6005-G80Y)

**4516**  
1 x LED MODULE 24V 15W.   
LED 2700 K. CRI > 90. 1044,95 lm. 70 lm/W  
Driver Constant Voltage 24V. 100~277V. 50/60Hz.

Body: Steel.  
Cover: Steel.  
Net weight: 16,5 Kg.

**4516 29 /10** Brown D1 (NCS S 8005-Y50R)

**4516 53 /10** Green M1 (NCS S 6005-G80Y)

**4521**  
1 x LED MODULE 24V 15W.   
LED 2700 K. CRI > 90. 1031,39 lm. 69 lm/W  
Driver Constant Voltage 24V. 100~277V. 50/60Hz.

Body: Steel.  
Cover: Steel.  
Net weight: 16,1 Kg.

**4521 29 /10** Brown D1 (NCS S 8005-Y50R)

**4521 53 /10** Green M1 (NCS S 6005-G80Y)

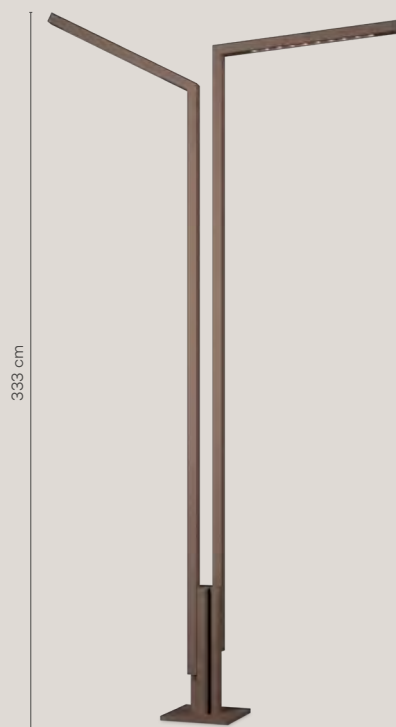

333 cm

32 x 32 cm

4537 p. 80

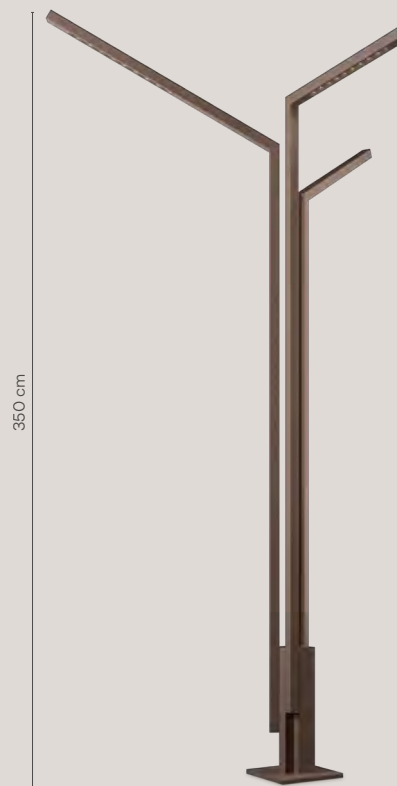

350 cm

32 x 32 cm

4538 p. 80

**4537**

2 x LED MODULE 24V 15W.

LED 2700 K. CRI &gt; 90. 2076,32 lm. 69 lm/W

Driver Constant Voltage 24V. 100~277V. 50/60Hz.

Body: Steel.

Cover: Steel.

Net weight: 41,76 Kg.

4537 29 /10 Brown D1 (NCS S 8005-Y50R)

4537 53 /10 Green M1 (NCS S 6005-G80Y)

LED IP65 CE EAC Multi-volt

**4538**

3 x LED MODULE 24V 15W.

LED 2700 K. CRI &gt; 90. 3045,38 lm. 68 lm/W

Driver Constant Voltage 24V. 100~277V. 50/60Hz.

Body: Steel.

Cover: Steel.

Net weight: 49,86 Kg.

4538 29 /10 Brown D1 (NCS S 8005-Y50R)

4538 53 /10 Green M1 (NCS S 6005-G80Y)

LED IP65 CE EAC Multi-volt